



Record System 20 FTA/FBO

User manual

Document identification

Article nr.: 102-020401246
Version: V3.0
Publication date: 04/02/2025

Original Instructions

Subject to technical modifications
Copyright © agtatec ag

Table of Contents

Glossary	5
List of changes	6
1 Safety	7
1.1 Presentation of warning signs	7
1.2 General hazards	7
1.3 Electronic equipment reception interference	12
1.4 State of technology	12
1.5 Personal protective equipment	12
1.6 Product liability	13
1.7 Spare parts and liability	13
2 General information	14
2.1 Purpose and use of the instructions	14
2.2 Manufacturer agtatec ag	14
2.3 Target groups	14
2.4 Terms and definitions	15
2.5 Compliance information	15
3 Description	16
3.1 Intended purpose of use	16
3.2 Components	16
3.3 Overview illustration	17
3.4 Signage	18
3.5 Function description	19
3.5.1 FBO safe door opening in case of emergency	19
3.6 FTA lintel and header mounting	20
3.6.1 FTA lintel mounting	20
3.6.2 FTA header mounting	20
3.7 FBO lintel and header mounting	21
3.7.1 FBO lintel mounting	21
3.7.2 FBO header mounting	21
4 Options	22
5 Specification	23
5.1 Technical Data	23
6 Operation	24
6.1 BDE-D Description	24
6.2 Selection of operating modes	24
6.3 Selection of special functions	25
6.4 Operation modes and key functions	25
6.5 Operation modes	27
6.6 Locking/unlocking the control unit via the keypad	28
6.7 Locking the control unit with a key (option)	29
6.8 Programming level	29
6.8.1 Menu functions	30
6.8.2 Settings	30
7 Inspection and maintenance	31
7.1 Functions and safety check	31
7.1.1 General remarks	31
7.1.2 Monthly check-up list	32
7.1.3 Checking safety devices	33

Table of Contents

7.2	Operator duties	33
7.3	Commissioned technician	35
7.4	Logbook	35
7.5	Maintenance and regular inspection	35
7.5.1	Maintenance FTA / FBO	36
7.6	Door care	36
7.7	Recommended and planned spare- and wear parts	37
7.8	Conclusion and reporting	37
8	Emergency actuation of the door	38
8.1	Operating door in emergency.....	38
8.2	Emergency opening with current supply	38
8.3	Emergency opening in case of power failure with a back-up battery (optional).....	38
8.4	Emergency operating using Bowden cable (option).....	38
8.4.1	Available versions	38
8.4.2	Procedure for an emergency opening.....	39
8.4.3	Procedure for an FBO emergency opening	39
8.5	Manual closing	40
8.5.1	Manual closing - Step 1	40
8.6	Closing and locking the door.....	41
9	Troubleshooting	42
9.1	Error display and troubleshooting	42
9.2	Behavior in event of faults	42
9.2.1	Display on the control unit.....	42
9.2.2	BDE-D Possible troubleshooting.....	42
9.2.3	Resetting the control unit	43
9.2.4	Control unit BDE-D does not react.....	43
10	Taking out of service and disposal	44
10.1	Decommissioning.....	44
10.2	Dismantling and disposal	44

Glossary

BDE-D

Control unit with display

BDE-M

Control unitl mechanical

CO48

Opening system with mechanical energy storage in case of power failure, intended for France.

DoC

Declaration of conformity

Dol

Declaration of incorporation

FBO

Folding door drive with break out function

FTA

Folding door drive

LED

Light emitting diode

PE

Protective earth

RAD

Motion sensor

RIC

Safety sensor

SSK

Key pivot contact

TOS

Total opening system

VRR

Locking device

List of changes

List of changes

Change	Location
Complete revision of all sections and content	Entire document
New section structure	Entire document
Revision of all graphics	Entire document

1 Safety

1.1 Presentation of warning signs



DANGER

Warning against an imminent or latent hazardous situation that can lead to electric shock and cause serious injury or death.



DANGER

Warning against an imminent hazardous situation that can lead to severe injury or death.



WARNING

Warning against a latent hazardous situation that can lead to severe injuries or death and cause substantial property damage.



CAUTION

Warning against a potential hazardous situation that can lead to minor personal injury and property damage.



NOTICE

Useful advice and information to make sure of a correct and efficient workflow of the system.

1.2 General hazards

The system can cause the hazards in this section even when it is used as intended.

To reduce the risk of malfunction, damage to property or injury to persons and to avoid dangerous situations, the safety instructions listed here must be observed. Save this manual for future reference.

The specific safety instructions in the other sections of this manual must also be observed.



DANGER

Electric current.

In case of contact with live parts, there is an immediate danger to life because of electric shock. Damage to or removal of the insulation or individual components can be life-threatening.

- a) Make sure that only approved personnel work on the electrical system.
- b) Make sure that all poles are voltage free and that this is maintained for the duration of the work.
- c) Disconnect all poles from voltage before you start the work (cleaning, maintenance, replacement) on active parts of the electrical systems and the equipment.
- d) Keep moisture away from live parts. This can lead to a short circuit.
- e) Do not bridge fuses or put them out of operation.
- f) Do not connect the power supply or a battery until all work has been completed.
- g) Do not use a damaged supply cord. Only the manufacturer, its service agent or a similarly qualified person is permitted to replace a damaged supply cord.



DANGER

Faulty connection of the mains power supply.

Risk of electric shock and property damage if the mains power supply to the system is not installed with a safe method.

- a) The mains power supply must be installed with protection (fuse, circuit breaker).
- b) An all-pole mains disconnection switch with isolating capabilities of Category III must be installed.
- c) All installation must be done correctly, refer to local regulations.



DANGER

Fire in an electronic system.

Risk of electric shock if you use a water-based fire extinguisher for a fire in an electrical system.

- a) Use a fire extinguisher of type carbon dioxide (CO₂) or ABC dry powder.



DANGER

Faulty safety devices of the fire protection system.

Danger to life if the safety devices of the fire protection system do not work. This can cause severe injuries or death.

- a) Do not disconnect the fire protection system from the power supply overnight.
- b) Do not disassemble, put out of operation, or manipulate the safety devices.
- c) Do not remove safety instructions from the system.
- d) Do not block, hold open, or otherwise prevent the fire doors from closing.
- e) Inspect and do a service and maintenance of the fire protection system.
- f) Always follow the local applicable regulations or the regulations in a maintenance contract.
- g) Examine and maintain the condition of the fire protection system.



DANGER

Faulty safety devices.

Risk of personal injuries that can lead to death or material damages if the safety devices are faulty, manipulated, or put out of operation.

- a) Make sure that all safety devices (breakouts, sensors, lock release, and so on) operate correctly.
- b) Do not disassemble, put out of operation, or manipulate the safety devices.
- c) Examine and perform service and maintenance of the safety devices.
- d) Always follow the local applicable regulations or the regulations in a maintenance contract.



DANGER

Moving system.

If the system moves, careless behaviour can lead to severe personal injuries to limbs or severance of limbs.

- a) Do not reach in when parts of the system move.
- b) Keep a distance when parts of the system move.
- c) Do not bump into or touch the system when it moves.
- d) Do not open or remove protective covers during operation.
- e) Do not permanently remove covers from the system.
- f) Only carry out inspection, service, maintenance, or cleaning when the system is stationary and the power is OFF.
- g) Danger points must be safeguarded up to a height of 2500 mm from the floor level.



WARNING

Maintenance and checks during operation.

Risk of personal injuries if the system is in operation during service and maintenance.

- a) Make sure that the power is OFF and that the system is stationary before you do checks, repairs, service, maintenance, and cleaning.
- b) Before you start the work, make sure that there are no persons in the system or in the close area of the system..



WARNING

Incorrect use and/or installation.

Incorrect use and/or installation can lead to severe injuries and/or cause substantial material damage.

- a) Read and obey all instructions regarding safe use and/or assembly.
- b) Make sure that all connection points between the door system and the building are sufficiently strong, even and level.
- c) Only use brand-name approved components. Other components may have a negative effect on the safety of the system.



WARNING

Heavy parts.

Lifting the heavy parts can cause personal injuries.

- a) Always be at least two persons when you lift and handle the heavy parts. Refer to local regulations.
- b) Use the tools provided for lifting.



WARNING

Unapproved persons without supervision using the system.

Risk of personal injuries, malfunction, or material damage to the property if unapproved persons use the system.

- a) Infants and children under 8 years of age are not allowed to be within the opening area of the system without supervision of an adult.
- b) Children must not play, climb on, clean, or maintain the system or the fixed/remote controls.
- c) Children must not play with the system, the fixed controls, or the remote controls.
- d) Keep children away from the fixed controls and the remote controls.
- e) Persons with limited physical, sensory, or mental abilities can only use the system under supervision.
- f) Unapproved persons must have received and understood the instructions on how to use the system.



WARNING

Locked in persons in the building.

Risk of personal injuries and material damage.

- a) Before the system is set to locked, make sure that the locked area is empty and that no persons are locked in.



WARNING

The system can open, close, or turn unexpectedly.

Risk of material damage or personal injuries because of unforeseen opening, closing, or turning of the system.

- a) No persons can be present in the opening area of the system.
- b) Ensure that moving objects such as flags or parts of plants do not enter the detection range of the sensors.
- c) Do not make any settings on the control unit when the system is in use.
- d) Make sure that approved personnel immediately correct the errors.
- e) Remove objects from the opening area.
- f) Do not disassemble, put out of operation, or manipulate the safety devices.
- g) Do not dash through a closing system.



CAUTION

Incorrect settings.

Incorrect settings can lead to malfunctions, material damage, or personal injuries.

- a) Do not disconnect the system from the power supply overnight.
- b) Make sure that only approved personnel adjust the settings.
- c) Do not disassemble, put out of operation, or manipulate the safety devices.
- d) Make sure that only approved personnel correct errors.
- e) Follow locally applicable regulations, or make sure to have a maintenance contract for service and maintenance.

**CAUTION****Insufficient cleaning or care.**

Insufficient or inattentive cleaning or care of the system can lead to malfunctions, material damage or personal injuries.

- a) Examine the sensors regularly for dirt and clean them if necessary.
- b) Regularly remove dirt accumulations from the product and its close surroundings, for example the floor, in the floor rail, or under the floor mat.
- c) Keep the system free from moisture like water, snow and ice.
- d) Do not use aggressive or caustic cleaning agents.
- e) Use road salt or loose chippings only conditionally.
- f) Put the floor mat without folds and flush with the floor.
- g) Do not lean or attach equipment required for cleaning purposes, such as ladders or similar, to the system.

**CAUTION****Imbalance and damaged parts.**

Imbalance, wear, or damage to cables, springs, and fastening parts can cause material damages.

- a) Inspect the installation during the function- and safety check for imbalance and damaged parts.
- b) Do not use the equipment if repair or adjustment work needs to be carried out.

**CAUTION****Product damage.**

If the product packages are not properly stored the product this can lead to personal injuries, material damage or malfunction.

- a) Always store the packages indoors, in a dry condition at all times during transportation and re-loading.
- b) The package has plastic tarpaulin around it and can be stored outdoors for a shorter while during installation, at the installation site.

**NOTICE**

Observe and comply with the country-specific regulations.

**NOTICE**

To prevent not wanted activations of the system, keep the area around the system clear. Moving objects such as flags or parts of plants must not be allowed to enter the detection range of the sensors.

1 Safety

1.3 Electronic equipment reception interference

The equipment can generate and use radio frequency energy. If the equipment is not installed and used properly it can cause interference to radio, television reception or other radio frequency type systems.

If other equipment does not fully comply with immunity requirements, interference may occur. There is no guarantee that interference will not occur in a particular installation.

If the equipment causes interference to radio or television reception, try to correct the interference:

- a) Turn the equipment ON and OFF to determine interference.
- b) Reorient the receiving antenna.
- c) Move the receiver with respect to the equipment.
- d) Move the receiver away from the equipment.
- e) Connect the receiver into a different outlet so that equipment and receiver are on different branch circuits.
- f) Make sure that protective earth (PE) is connected.

If necessary, consult the dealer or an experienced electronics technician for additional suggestions.

1.4 State of technology



NOTICE

Installation, commissioning, inspection, and maintenance must only be done by approved technicians. We recommend you to have a service agreement.

Record the work in the check list and give it to the customer for safe keeping.

This system was developed using state of the art technology and officially recognized technical safety regulations. The system, depending on its options and variants, comply with the requirements of the Machine Guidelines 2006/42/EG as well as EN 16005 and DIN 18650 (D).

Danger can occur if you do not use the system as intended.

1.5 Personal protective equipment

Use personal protective equipment to protect persons from adverse effects on the health. Personnel must wear personal protective equipment during the various work activities on and with the system.

Depending on the place of work and the working environment, the protective equipment varies and must be adapted to the situation. In addition to the protective equipment for specific work, the work site can require other protective equipment (for example a harness).

In hygiene-protected areas, special or additional requirements of personal protective equipment can be necessary. These requirements must be thought of when choosing personal protective equipment. If there is any uncertainty regarding the choice of personal protective equipment, the safety officer must be consulted at the place of work.

Personal protective equipment is explained below:



Hearing protection protects the hearing from noise. As a rule of thumb, mandatory to use hearing protection when a normal conversation with other people is no longer possible.



The head protection protects against falling and flying parts and materials. The head protection also protects the head from bumping into hard objects.



Protective goggles protect the eyes from flying parts, dust, splinters or splashes.



Protective gloves protect the hands from friction, abrasions, punctures, or serious injury and from burning caused by contact with hot surfaces.



Safety shoes protect the feet from crushing, falling parts and slipping on surfaces. The puncture resistance of the shoes ensures, that pointy objects do not penetrate the foot.



The high-visibility vest makes the personnel stand out and easily seen. With improved visibility and attention, the high-visibility vest protects personnel in busy work areas from collisions with vehicles.

1.6 Product liability

To guarantee a reliable and trouble-free operation of the system, only use parts that the manufacturer recommends. The manufacturer declines any liability for damages as a result of unapproved modifications to the system or the use of parts that are not permitted.

Refer to regulations, the responsibility of the owner or caretaker of the equipment are as follows:

- That the equipment operates correctly, so that it gives sufficient protection in regard to safety and health.
- That someone with documented competence in the equipment and in applicable regulations operates and regularly maintains, inspects, and services the equipment.
- That the provided Service log book and Site acceptance test and risk assessment are kept available for maintenance and service records.
- That the inspection covers the emergency opening function (when applicable).
- That the closing force is appropriate for the system size on fire-approved systems (when applicable).

1.7 Spare parts and liability

Reliable and trouble-free operation of the door is only guaranteed when using parts that were recommended by the manufacturer. The manufacturer declines any liability for damages resulting from unauthorized modifications to the door or the use of parts that are not permitted.

2 General information

2 General information

2.1 Purpose and use of the instructions

These instructions are an integral part of the system and enable efficient and safe handling of the system. In order to ensure proper functioning, the instructions must be accessible at all times and kept in the immediate area of the system.

Although only the male form has been chosen for reasons of better legibility, the information refers to members of both sexes.

The operator must have read and understood the manual before starting any work. The basic requirement for safe working is to follow the safety instructions and the handling instructions. In addition, the local regulations and safety rules apply.

The manual can be handed over in extracts to instructed personnel who are familiar with the operation of the system.

The illustrations are for basic understanding and may differ from the actual presentation. Specific representations are contained in the drawings.



NOTICE

A replacement of the instructions is available from the supplier or on the website.

2.2 Manufacturer agtatec ag

agtatec ag

Allmendstrasse 24

CH – 8320 Fehraltorf

Switzerland

Phone: +41 44 954 91 91

2.3 Target groups



WARNING

Risk of injury if the personnel are not approved.

If unapproved personnel work on the system or are in the danger zone of the system, dangers can occur. Severe injuries and substantial material damages can be the consequence.

- a) Only approved personnel must carry out work on the system.
- b) Keep unapproved personnel away from danger areas.

This manual is intended for the target groups listed below:

- The person who is responsible for the technical maintenance of this system.
- The person who operates the system every day and has been instructed.

2.4 Terms and definitions

Term	Definition
Approved personnel	<p>Authorised personnel are entitled to perform the following work:</p> <ul style="list-style-type: none"> – Disassembly – Assembly – Commissioning – Operation – Audit – Maintenance – Troubleshooting – Decommissioning <p>The approved personnel have several years of professional experience in the technical field, for example, as mechanics or machine fitters.</p> <p>The approved personnel are aware of the residual risks arising from the installation site and, due to their professional training, knowledge, and experience, can carry out the work assigned to them and to independently identify and avoid possible danger points.</p>
Approved representative	The approved representative takes over certain parts of the manufacturer's obligations about fulfilling the requirements of the Machinery Directive. In particular, the approved representative can also place the system on the market and/or sign EC declarations of incorporation.
Life phases	All phases of the system's condition and use are referred to as life phases. This applies from the time the system leaves the factory until it is disposed of.
Manufacturer	The manufacturer is whoever designs and/or builds machinery or incomplete machinery under the scope of the Machinery Directive.
Personnel	All persons who carry out activities on and with the system are referred to as personnel. Personnel can be, for example, the operator, the cleaning staff, or the security staff. The personnel meet the personnel qualifications required by the manufacturer.
Service technician	Experts and specialists or representatives approved by the manufacturer to perform commissioning, maintenance, and servicing.
System	<p>The term is used in these instructions as a synonym for the product. Door operators, revolving doors, sliding doors, gates, and so on are referred to as a system.</p> <p>If information in these instructions refers to a specific type, this is shown accordingly in the text.</p>
System operator	The respective owner is referred to as the system operator, regardless of whether they operate the system as the owner or pass it on to third parties.
User	Users are all the persons who use the system.

2.5 Compliance information

This product complies with European directives, regulations and standard EN 16005.

The CE marking on the product indicates conformity with European directives and regulations together with the Declaration of conformity (DoC) or the Declaration of incorporation (DoI), accompanying the product.

The full DoC and the full DoI is available for download on our website.

3 Description

3 Description

3.1 Intended purpose of use

The system is designed exclusively for use as a pedestrian passage. The installation must only occur in dry areas. If there are deviations, then proper waterproofing and water drains will be required on site.

Any other application or use beyond this purpose is not considered to be an intended purpose. The manufacturer bears no liability for any resulting damage; the operator alone shall bear the associated risk.

The intended purpose also includes observation of the operating conditions specified by the manufacturer, in addition to regular care, maintenance and repair.

Interventions in or alterations to the installation performed by non-approved maintenance technicians exclude the manufacturer's liability for consequential damages.



NOTICE

The operation of an automatic door in combination with a wicket door must only take place if the latter is in a secured position.

3.2 Components

The automatic folding door operator FTA / FBO consists of following main components:

Control system:	Intelligent, self-learning microprocessor-regulated control system.
Drive unit:	DC drive motor, need of minimal maintenance, with electronic door travel measurement and integrated thermal protection circuit.
Power supply:	Compact power supply with integrated entry filter and overvoltage protective device.
Control unit:	Optionally to choose between a programmable electrical or simple mechanical control unit.
Locking device (optional):	Electromagnetically locking device. The gear belt pulley will be blocked.
Battery-pack (optional):	To maintain the automatic door functions during a power loss.
Sensor technology:	Esthetical release – and self-guarding safety devices with adjustable sensitivity provide an optional, faultless and safe function of the door installation.

3.3 Overview illustration

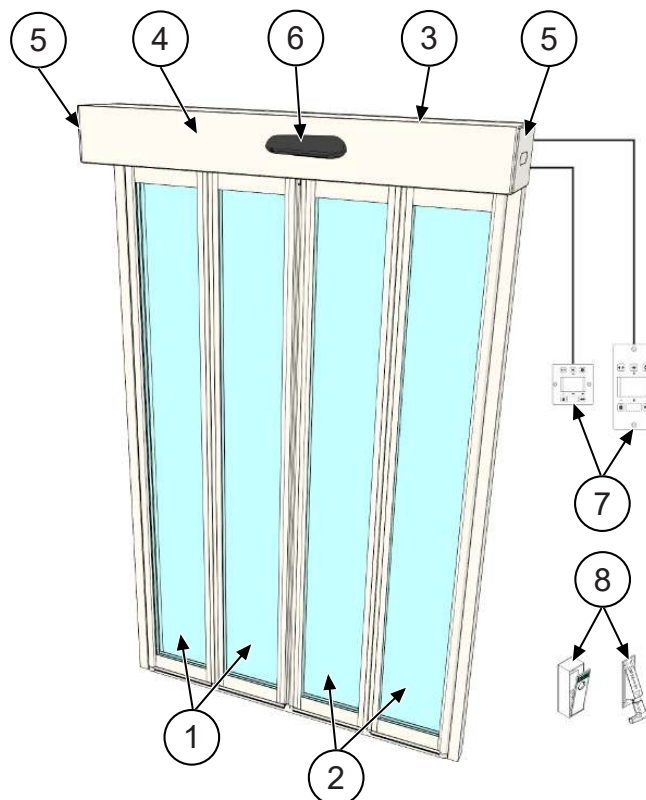

Item	Description
1	<u>FTA</u> 107 Door Wing left <u>FBO</u> 108 Door Wing left
2	<u>FTA</u> 107 Door Wing right <u>FBO</u> 108 Door Wing right
3	Door operator <u>FTA</u> 20 Door operator <u>FBO</u> 20
4	<u>FTA</u> Casing <u>FBO</u> Casing
5	End Cap left End Cap right
6	Combi Sensor <u>RIC</u> 290
7	<u>BDE-D</u> Electronic Operating Unit with Display
8	Manual unlocking, HE/HEI

3 Description

3.4 Signage

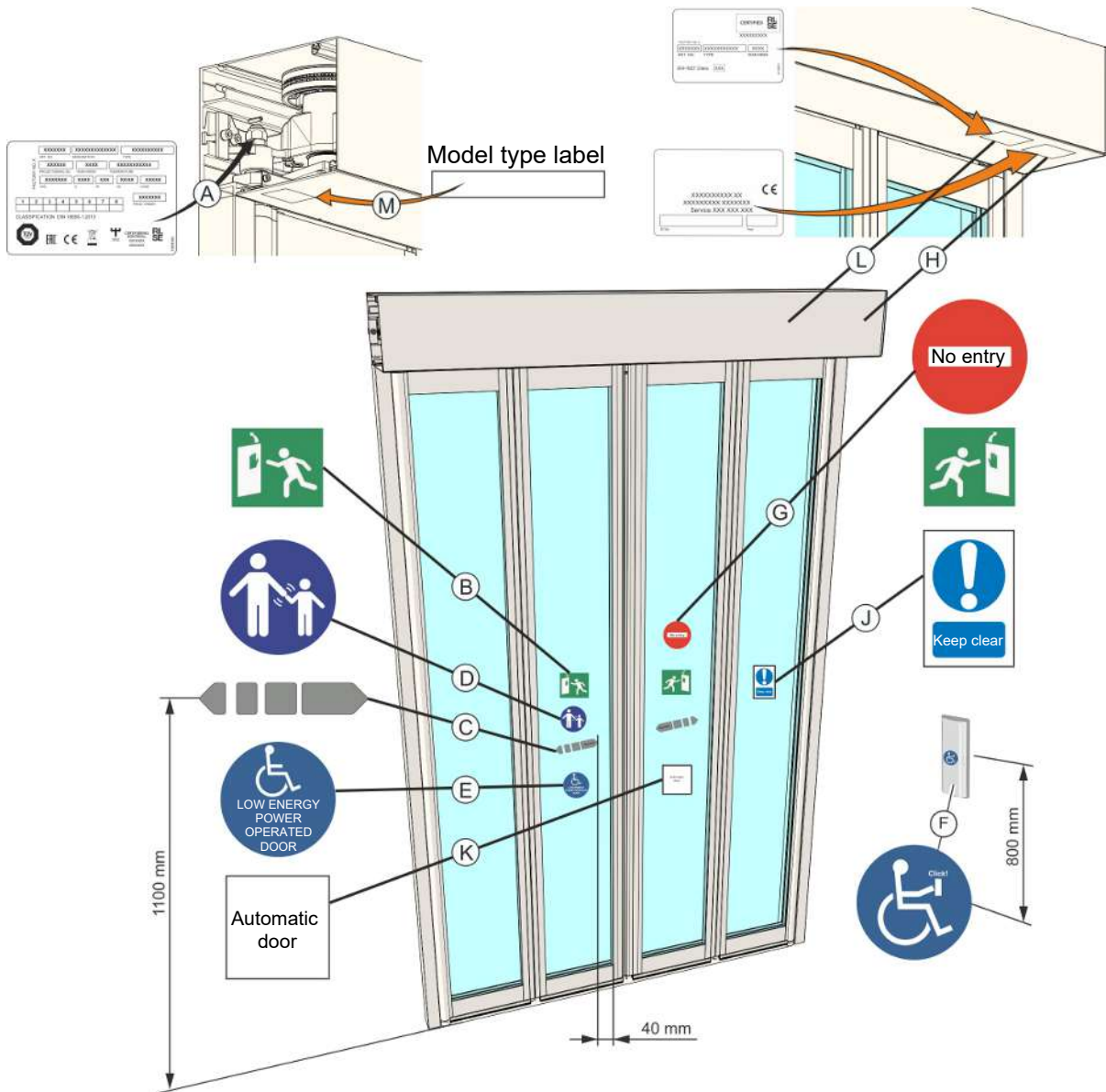

Label	Description	Requirement?
Check that all required signages are applied and intact. Mandatory indicates that the signage is required by European directives and equivalent national legislation outside the European Union.		
A	Product label	Mandatory
B	Emergency break-out	Mandatory, if approved for escape route.
C	Company door sticker	Mandatory, if applicable to highlight the presence of the glass (applied to all moving glass sections).
D	Supervision of children	Mandatory, according to national regulations. Recommended, if the risk analysis shows usage by children (applied to both sides of the door).
E	Operator designed for persons with disabilities	Recommended, if applicable (applied to both sides of the door).
F	Activation by people with disabilities	Recommended, if applicable.
G	No entry, identifying one-way traffic	Mandatory in GB and US, if applicable. Not included in the product.
H	Local product label	Mandatory, if per national legislation.

Label	Description	Requirement?
J	Keep clear	Mandatory in GB, if applicable. Not included in the product.
K	Automatic door	Mandatory in GB, if applicable. Not included in the product.
L	Burglary resistant label	Mandatory if it is a burglary resistant system.
M	Model type label	Mandatory

3.5 Function description

In the standard "Automatic" operating mode, the door system is opened by an actuating device (e.g. radar) that responds to approaching persons or objects. The door closes after the door hold-open time, provided no further opening pulse is received or nobody enters the presence sensor scanning field.

In the "Lock" operating mode, the door can only be opened by means of an optional key-operated contact (**SSK**). The door closes after the SSK door hold-open time, provided no further opening pulse is received or nobody enters the presence sensor scanning field.

An obstruction of the door leaves during **Closing** leads to an immediate re-opening (automatic reverse). The obstruction's position is recorded by the door operator, and this position is approached slowly when next closing. An obstruction of the door leaves during **Opening** results in an immediate stop.

A mechanical release device provides protection against being jammed between the wall and the open door.

3.5.1 FBO safe door opening in case of emergency

The **FBO** folding door was specifically designed for use in escape and rescue routes.

Normally, the door leaves open and fold inwards. In an emergency, the escape route is opened by unlatching the upper door fitting from its arrester by means of slight pressure on the door leaves, which will then swing open together with the door fitting.

3 Description

3.6 FTA lintel and header mounting

3.6.1 FTA lintel mounting

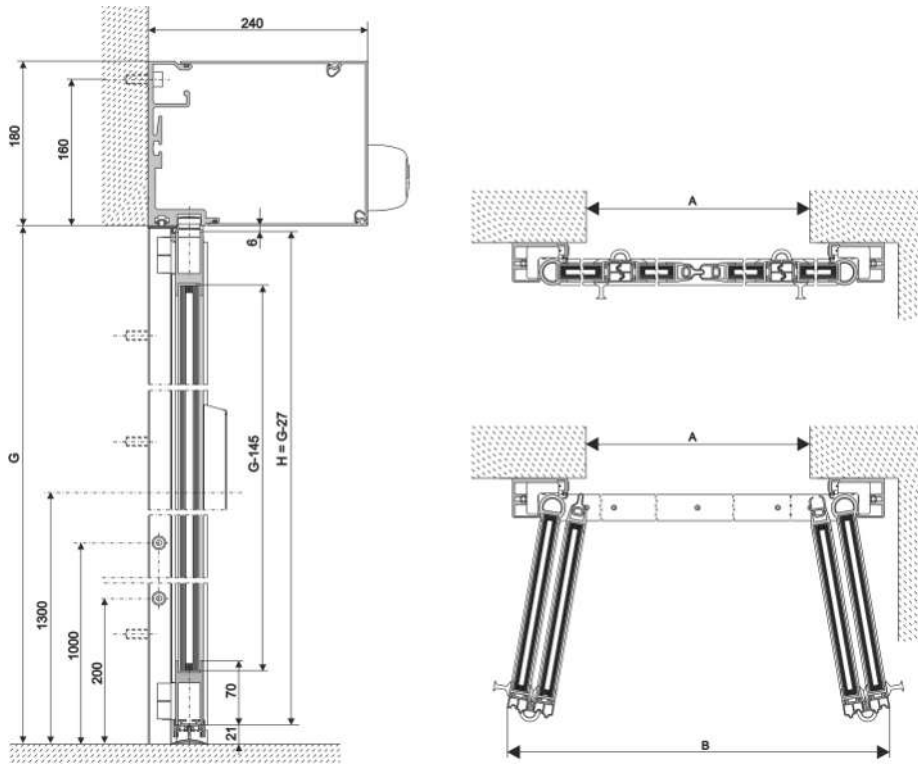

3.6.2 FTA header mounting

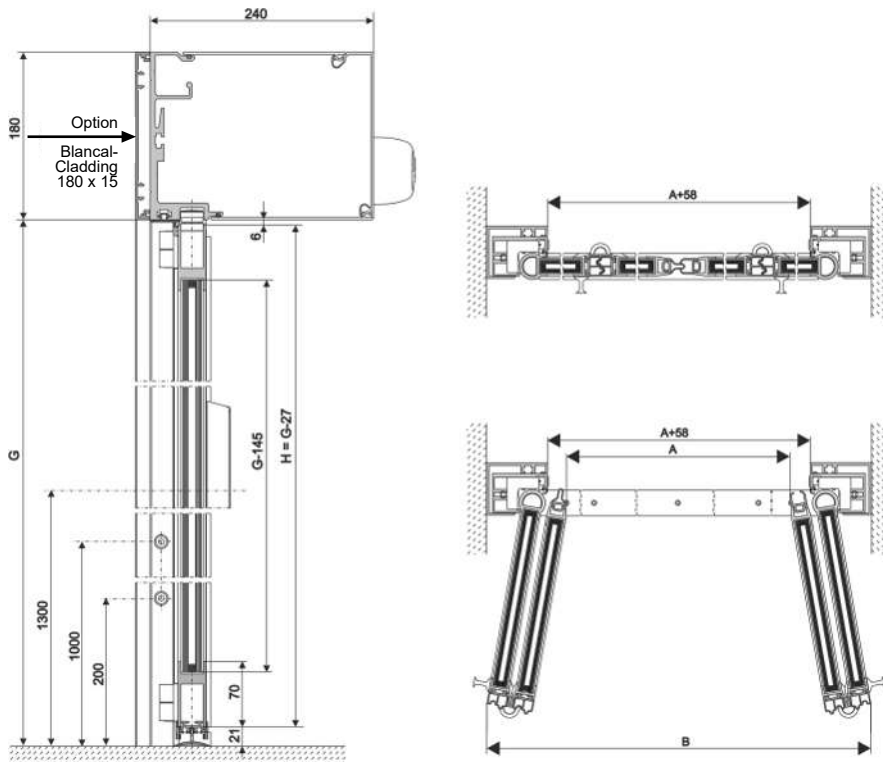

3.7 FBO lintel and header mounting

3.7.1 FBO lintel mounting

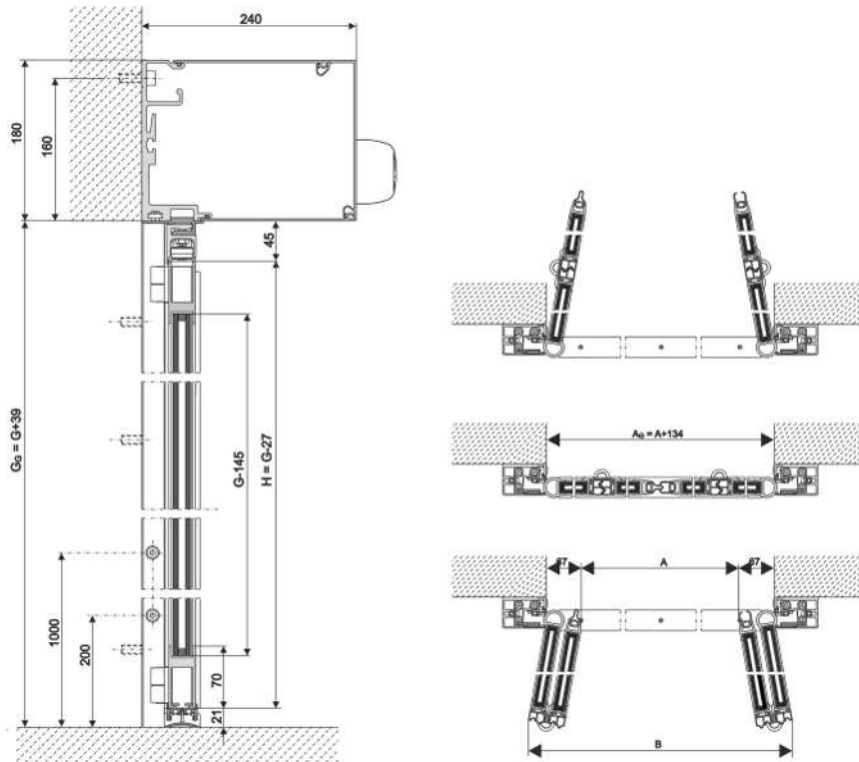

3.7.2 FBO header mounting

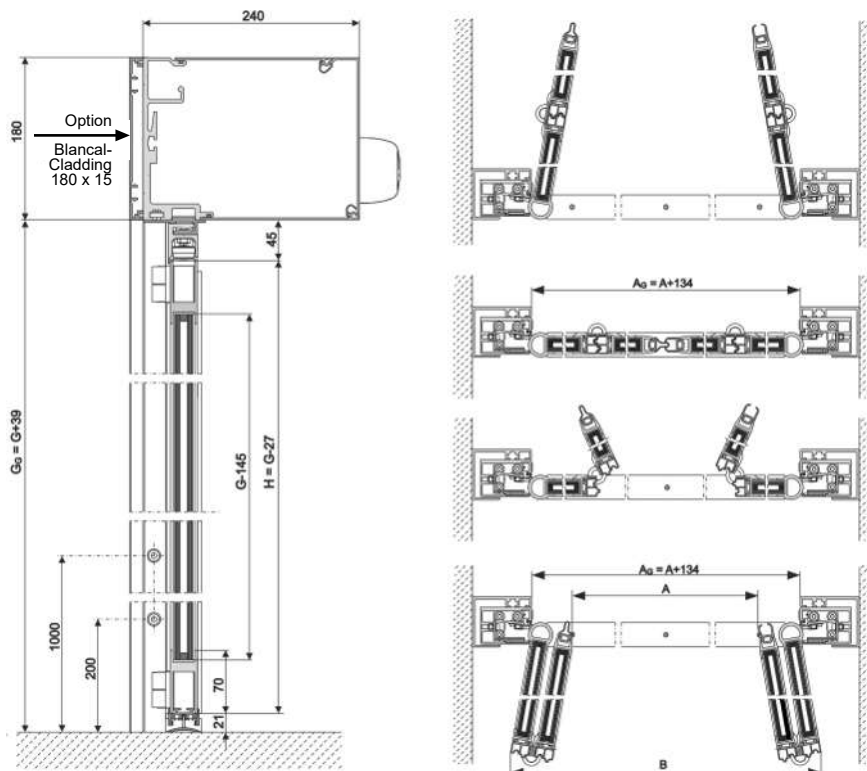

4 Options

The system complies with all applicable safety regulations, but it is possible to enhance the safety and comfort with the add-ons.

Contact your local company for a detailed description.

Possible Options are as follows:

- Different casings
- Casing ABS + HE
- Door leaf surveillance
- Locking and casing surveillance
- Mechanical emergency release
- ATE20 folding door with CAN connection
- Swivel stop
- Motion detectors on door leaves

For details on the different options, please contact our service center.

5 Specification

5.1 Technical Data

Function	Range	Step size	Factory setting
Opening speed	3-70 cm/s	1,75 cm/s	50 cm/s
Closing speed	3-50 cm/s	1,25 cm/s	40 cm/s
Reduced opening width	Approx. 2% - 100%	Approx. 4-10 cm Steps acc. leaf position	62,5%
Door time delay	0-20 s	0,5 s	1 s
Door time delay SSK	0-20 s	0,5 s	10 s

Mains voltage (230V):	100-240 VAC, 50/60 Hz
Rated power:	90 VA
Temperature range:	-15 to +50 °C
Humidity range:	Up to 85% rel. humidity, not condensing

6 Operation

6 Operation

6.1 BDE-D Description

The BDE-D electronic operating unit is a convenient input and output unit for operating and programming control units in our door operators.

Logically arranged buttons allow intuitive operation of the door and navigation through the operator-specific menu structure. The LCD display with backlighting provides details and information on the door status using symbols and plain text.

There is a choice of several languages, which increases user-friendliness on the one hand and facilitates service interventions on the other.

The connection to the control units is made via the CAN bus.

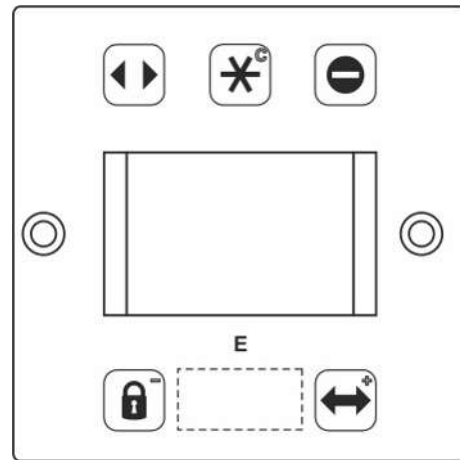

6.2 Selection of operating modes





Key	Operating mode	Symbol displayed	Function
	Continuously open	 Continuously open	System remains open until another operating mode is selected.
	Reduced opening width	 Automatic	Unobstructed access through the system in both directions. Reduced opening width.
	One-way	 One-way	System opens only in one direction (e.g. for shop closing time).
	Locked	 Locked	System is closed and locked (if there is a locking device). System remains locked even in case of power failure.
	Automatic	 Automatic	Unobstructed access through the system in both directions. Maximum opening with.
	Menu key		Access to parameter menu. Activating the operation lock. Restart control unit. Restart hardware BDE-D.

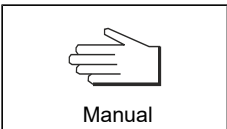

NOTICE

The reduced opening width is also effective with operating modes (One-way) and (Continuously open).

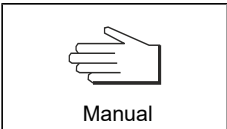
6.3 Selection of special functions







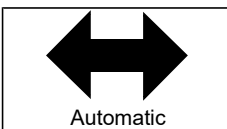

Key operation	Function	Display	Description
	Manual mode	 Manual	<ul style="list-style-type: none"> – Press key twice. – System opens/stops on 2nd key stroke. – System can be operated manually. Back to another operating mode. <ul style="list-style-type: none"> – Activation of the selected key (e.g. Automatic).
	Manual mode	 Manual	<ul style="list-style-type: none"> – Press key for 2 seconds. – System can be operated manually. Back to another operating mode. <ul style="list-style-type: none"> – Activation of the selected key (e.g. Automatic).
	Single opening	 Locked	<ul style="list-style-type: none"> – System is closed and locked. – 1 keystroke unlocks the system (if available). – An opening/closing cycle is performed. – Once closed, system locks again.

6.4 Operation modes and key functions

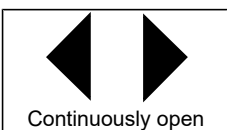

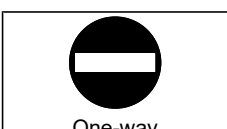
The keys on the Operating Unit **BDE-D**, are used to set the door system operation modes in the main menu. The parameters of the door system are set in the sub menu.

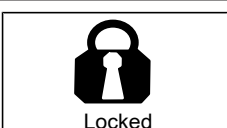
The key functions are divided into main menu and sub menu.

Main menu

Key	Name	Operation	Function	Display on LCD
	Automatic key	Press key 1 x	Automatic operation via sensors.	 Automatic
	Continuously open key	Press key 1 x	For sliding door operator and swing door operator: Continuously open, sensors disabled.	 Continuously open
		Press key 2 x or hold it down for 2 seconds	For sliding door operator: Manual operation.	 Manual
	One-way key	Press key 1 x	Passage only possible from one direction.	 One-way
	Locking key	Press key 1 x	Door closed, sensors disabled.	 Locked
		Press key again	The door opens again, closes, and locks again. Can be opened with a key (optional).	 Locked

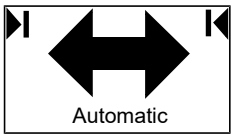
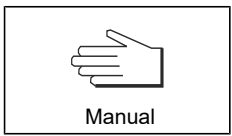
6 Operation

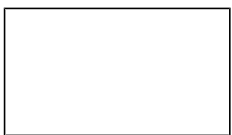





Key	Name	Operation	Function	Display on LCD
	Star key	Press key 1 x	For sliding door operator: Reduced opening width.	
		Press key 1 x	For swing door operator: Manual operation.	
	Menu key	Restart control device: Press key for 5 seconds Restart hardware BDE: press key for 12 seconds	Access to parameter menu. Enable control lock. Restart Operating Unit. Restart hardware BDE-D.	

Sub menu

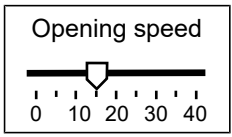

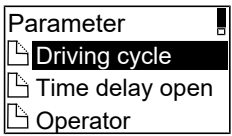
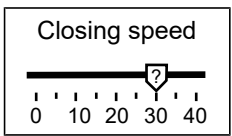
NOTICE

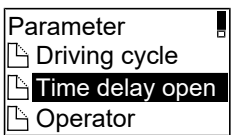
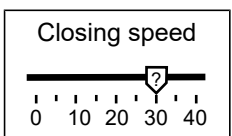
The system automatically returns to the main menu 3 minutes after the last entry.

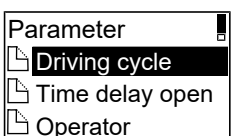
Key	Name	Operation	Function	Display on LCD
	Enter key	Press key 1 x to go to the next sub menu.	Select menu item, confirm entry.	
	Plus key	Press key 1 x to go down.	Navigates downwards in the menu.	
		Press key 1 x to increase the value.	Move the slide control to the right to increase the value.	
	Minus key	Press key 1 x to go up.	Navigates upwards in the menu.	
		Press key 1 x to reduce the value.	Move the slide control to the left to reduce the value.	
	Clear key	Press key 1 x to go to the previous menu.	Leave the menu item without saving.	

6.5 Operation modes

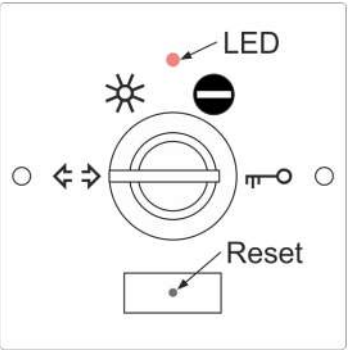

The diagram shows a circular unit with a sun icon (Automatic mode), a circle with a horizontal bar (One-Way mode), and a key icon (Locked mode). A red LED is at the top, and a 'Reset' button is at the bottom. A key switch is on the right side.





The **BDE-M** Mechanical Operating Unit is equipped with a key switch. This key switch can be used to set the various operating modes. The key switch can be removed in any position.

Operating display:

- The **LED** lights up when mains or battery voltage is present.

Perform Reset:

- This hidden button is operated by means of an approx. 25 mm long paper clip.
- For this purpose, there is a small hole in the middle of the logo.
- If the key is pressed for approx. 5 seconds, the controller is restarted (software reset). The saved settings are retained.

Key	Operating mode	Function
	Automatic mode with total opening width.	This operating mode corresponds to standard operation. Activation of a triggering device (e.g., RIC 290, RAD 290) opens the door. After the hold-open time has elapsed, the door closes again.
	Continuously open and manual operation.	Door opens and remains in the open position. It can then be moved manually.
	One-Way	The door opens only by activating the triggering element located on the inside of the door, or by an optional key switch contact (SSK).
	Locked	The door is automatically locked after it has been closed. Only with the key switch contact (SSK) can an opening be triggered with the last valid opening width. Caution: In the event of interrupted power , door opening in the locked state, without an additional battery or without manual release, is no longer guaranteed!

6 Operation

6.6 Locking/unlocking the control unit via the keypad



NOTICE

The locking of an escape route door is not permitted. The function of an escape route door would no longer be possible.



In order to prevent accidental locking of the doors during the use of the building, the choice of the operating mode for emergency exits must be protected according to the standard DIN EN 16005.

It is the responsibility of the operator of the automatic door with escape route function to lock the control unit in the "Automatic" position while the building is in use.

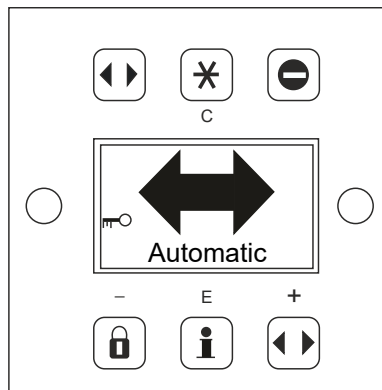

If the "Locked" operating mode is present, it must be protected with an access code so that only authorized personnel can set another operating mode.

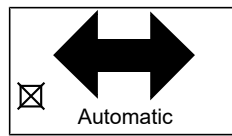

Locking the control unit

Key sequence	Display	Description
  		<ul style="list-style-type: none"> – The control panel is locked. – The locked state of the <u>BDE-D</u> is shown on the display. – Unwanted manipulation of the control unit is made more difficult.

Unlocking the control unit

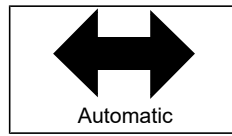
Key sequence	Display	Description
  		<ul style="list-style-type: none"> – The control panel is unlocked. – The unlocked state of the <u>BDE-D</u> is shown on the display. – Free selection of operating modes and special functions is possible.



NOTICE

The system remains in the previously selected operating mode.

6.7 Locking the control unit with a key (option)



NOTICE

The locking of an escape route door is not permitted. The function of an escape route door would no longer be possible.

In order to prevent accidental locking of the doors during the use of the building, the choice of the operating mode for emergency exits must be protected according to the standard DIN EN 16005.

It is the responsibility of the operator of the automatic door with escape route function to lock the control unit in the "Automatic" position while the building is in use.

The BDE-D operating unit can be effectively protected against unauthorized adjustment of the operating mode via an external operating lock.

If the "Locked" operating mode is present, it must be protected with a key switch so that only authorized personnel can set a different operating mode.

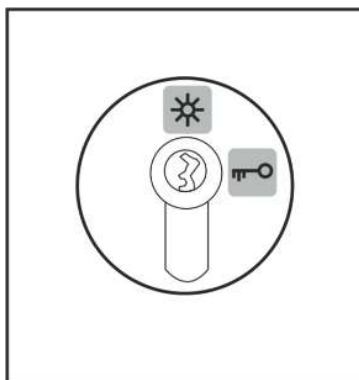

6.8 Programming level

Entry into the programming level is through a key sequence possible:

Key actuation			Function
			Entry into the programming level.
Key + and -			Navigate through the functions.
			Confirm the choice.

6 Operation

6.8.1 Menu functions

Function	Range	Step size	Factory settings
Closing speed	0-40	1	20
Reduced opening width Preferred setting: Key * and after that + and - to navigate upwards and downwards the menu. In the programming level use + and - to set the opening width. The door moves ONLINE to the opening width after confirmation of the entry.	0-40	1	26 RED 40
Door opening time delay.	0-40	1	0
Door opening time delay SSK.	0-40	1	4
Opening speed.	0-40	1	36

6.8.2 Settings

After the selection within the menu, the value can be changed by repeatedly pressing the keys + and -.

While pressing this key, the value will be displayed instantaneously.

Exit from this level is by pressing shortly the key * or, if no operation happened after a longer period of time.

7 Inspection and maintenance

Regular inspection and maintenance of the system by trained personnel, authorized by the manufacturer is the best guarantee for a long lifetime and trouble-free, safe operation.

The inspections and maintenance are required on the basis of the respective legal requirements and the manufacturer's interval specifications.

7.1 Functions and safety check

7.1.1 General remarks



DANGER

Electric Shock!

In case of contact with live parts, there is an immediate danger to life due to electric shock. Damage to or removal of the insulation or individual components can be life-threatening.

- a) Before starting work (cleaning, maintenance, replacement) on active parts of electrical systems and equipment, ensure that all poles are voltage free and that this is maintained for the duration of the work.
- b) Keep moisture away from live parts. This can lead to a short circuit.
- c) Never bridge fuses or put them out of operation.
- d) Do not connect the power supply until all work has been completed.
- e) Have work on the electrical system performed by qualified personnel only.



NOTICE

Specific inspections and maintenance may only be carried out by a specialist or a person trained for this purpose. The authorization of these persons is carried out exclusively by the manufacturer. The scope, result and time of the periodic inspections and maintenance must be recorded in an inspection book and a checklist. These documents must be kept by the operator.



NOTICE

The testing and/or servicing interval according to the manufacturer's specification is at least 1 to 2 times a year.



NOTICE

The recommended and planned spare and wear parts can be requested from your service centre.

According to current legislation, the operator of an automatic door system is responsible for its maintenance and safety.

With the care of the installation by the operator, accidents or defects can be avoided.

7 Inspection and maintenance

Testing

Type of test	Action
Visual inspection	Check door leaves, guides, bearings, limiting devices, sensors, and the securing of crushing and shearing points for damage.
Mechanical inspection	Check fastenings for tight fit.
Safety check (exit and escape routes)	Check sensors, safety devices, and monitoring devices for tight fit and damage.
Function testing	Check functioning of switches, operators, controllers, power or energy storage devices, and sensors. Also check the adjustment of the safety devices and the setting of all movement sequences including the end points.
Test run	Final overall review is carried out.

Servicing

Type of servicing	Action
Adjustment and cleaning	Clean and adjust bearings, sliding points, and power transmission. Check relevant fastening screws and retighten if necessary.

For documentation and information purposes, the testing and servicing work as well as the condition of the system are recorded in a test log book. The test log book must be kept for at least one year or until the next testing/servicing.

7.1.2 Monthly check-up list

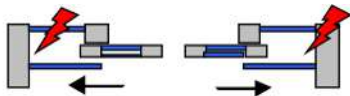
Test / Check	Procedure	Expected result
Motion detector	<ul style="list-style-type: none"> Walk at normal speed towards the door (from both directions) 	<ul style="list-style-type: none"> The sensor must cover the whole passage width The door opens in good time and at an appropriate speed to allow unhampered passage through the doorway
Door leaves / Side screens	<ul style="list-style-type: none"> Check the state of the glazing Check the state of the seals and profiles 	<ul style="list-style-type: none"> No glass damage No seals torn off (prevents energy loss) The door is the "showcase" of your company. Make sure it is maintained in perfect condition
Operator casing	<ul style="list-style-type: none"> Check the attachment of the operator casing 	<ul style="list-style-type: none"> It must be completely closed and correctly engage in the hinges
Protective screen (optional – country-specific)	<ul style="list-style-type: none"> Check the mechanical state of the protective screen Check the closing mechanism in particular 	<ul style="list-style-type: none"> A protective screen must protect against all kinds of crushing and shearing hazards

Semi-annual inspection work (FBO)

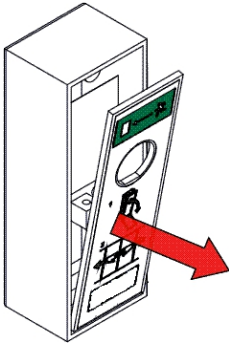
Test / Check	Procedure	Expected result
Manual unlocking device HEI 	– Pull the unlocking flap firmly	– Door unlocks – Door can be swung open manually

7.1.3 Checking safety devices



NOTICE

The service technician is responsible for proper installation and control.

New installations must fully comply with the EN 16005 standard. Commissioning of the door must be done together with the operator of the door, who must approve all functions of the door.

Already existing installations must be precisely checked during the official maintenance and service work and if necessary, by means of a risk analysis, the customer must be offered to bring the door into line with EN 16005 in terms of its safety.

- Countries in which DIN 18650 is also still valid:
Hazard analysis according to machine directives with reference to DIN 18650 - Fill out inspection report and have it signed by the customer. One copy is handed over to the customer. The inspection protocol and checklist are included in the maintenance instructions.
Furthermore, the functions in the following chapter, if available and not already covered by the aforementioned hazard analysis, are to be checked:
- Control of reversing when closing and stop when opening.
Obstruction of the door leaves during **closing** leads to immediate reopening (automatic reverse). The obstruction position is stored in the door drive and this position is approached smoothly during the next closing operation.
Obstruction of the door leaves during **opening** leads to an immediate stop.

7.2 Operator duties

Personal protection requires compliance with the standards and guidelines for publicly accessible facilities.

The system operator is responsible for carrying out testing and servicing.



NOTICE

According to EN 16005 / DIN 18650, the system must be inspected by an expert before initial commissioning and subsequently according to the manufacturer's instructions or at least once a year.



NOTICE

The installation must be inspected during the function and safety check for imbalance and signs of wear or damage to cables, springs and fastening parts.
The equipment must NOT be used if repair or adjustment work needs to be carried out.



CAUTION

Risk of malfunctions, material damage or injuries!

Insufficient or inattentive cleaning or care of the system can lead to malfunctions, material damage or injuries.

- a) Check the sensors regularly for dirt and clean them if necessary.
- b) Regularly remove dirt accumulations in the floor rail or under the floor mat.
- c) Keep the system free from snow and ice.
- d) Do not use aggressive or caustic cleaning agents.
- e) Use road salt or loose chippings only conditionally.
- f) Lay the floor mat without folds and flush with the floor.
- g) Equipment required for cleaning purposes such as ladders or similar must not be leaned on or attached to the system.

Tasks system operator

Task	Personnel	Time of implementation	Entry in the inspection book
Maintenance and cleaning of the sensors for safety and triggering	System operator	Weekly, or as required	No
Function and safety check	System operator	Monthly	No
Function test for fire doors	System operator	Monthly, or according to country-specific standards and guidelines	No

Tasks of qualified person

The inspection is carried out according to the manufacturer's test instructions.

The inspection usually takes place at the same time as the maintenance of the system.

The inspection also checks whether no changes have been made to the system since the last inspection and whether it meets the current safety requirements.

Task	Personnel	Time of implementation	Entry in the inspection book
Acceptance test	Qualified person	After assembly of the door system ready for operation	Yes
Servicing	Qualified person	1 x annually, or according to country-specific standards and guidelines	Yes
Test (inspection)	Qualified person	1 x annually, or according to country-specific standards and guidelines	Yes
Test (inspection) for door systems in escape routes	Qualified person	2 x annually, or according to country-specific standards and guidelines	Yes
Testing of fire doors	Qualified person	1 x annually, or according to country-specific standards and guidelines	Yes
Testing (inspection) for fire doors	Qualified person	1 x annually, or according to country-specific standards and guidelines	Yes
Servicing for fire doors	Qualified person	1 x annually, or according to country-specific standards and guidelines	Yes

7.3 Commissioned technician

Technicians are people:

- that on the basis of their technical training, knowledge, experience and work, perform their assigned test properly and identify and evaluate potential hazards.
- that have sufficient knowledge in the field of automatic door systems, relevant national safety regulations, accident prevention regulations, directives and generally recognized technical regulations, so they can judge the secure working condition of automatic door systems. These people include, for example, technicians from the manufacturing or supplying company, relevantly experienced, trained personnel authorized by the manufacturer or other persons with appropriate expertise.

Experts must submit their assessment objectively from the standpoint of personal and operational safety without being influenced by other requirements, such as i.e. economic circumstances.

7.4 Logbook

Extent, results and dates of the periodic inspections, must be documented and kept by the operator in an Inspection- and Maintenance logbook.

The contractor / operator must be informed of the results in writing.

The contractor / operator requires the inspection report (check list) for proof that the periodic inspection was performed and/or as documentation for construction authorities or accident and liability insurances, etc.



NOTICE

The following example of a logbook serves only as a template.

According to local regulations such a logbook must be attached to the door installation and all interventions and recurrent controls must be recorded in it.

Date	Error description / status-no.	Troubleshooting / maintenance / recurrent controls	Defects corrected / Parts replaced	Service technician signature

7.5 Maintenance and regular inspection

A safety inspection must be carried out before initial start-up and as required, as well as in accordance with the applicable regulations – **but at least twice a year**. We recommend having maintenance carried out at the same time.

A safety-related inspection must be performed by a competent service technician or an authorized partner.

Maintenance due is displayed on the BDE-D operating unit if this function has been activated. The interval for the output of this message is defined by the number of opening cycles and/or after a certain operating time has elapsed.

Regular inspection and maintenance of the equipment by trained personnel, authorized by the manufacturer, provides the best guarantee for a long service life and trouble-free safe operation.

We recommend concluding a service agreement with the service center responsible for your area.



NOTICE

A list of the recommended and planned spare and wear parts can either be seen in the appendix or can be requested from your service center.

7 Inspection and maintenance

7.5.1 Maintenance FTA / FBO

In addition to the general service and maintenance checklist, the following checks and settings must be carried out:



Checks / Adjustment	Interval
Check fastening of side posts for tight fit.	1 year
Check whether the door leaf slams open during opening. Install stop if necessary.	With every maintenance
Check whether the door leaves close in parallel.	With every maintenance
Check whether the two nuts for the door leaf height adjustment are correctly locked.	With every maintenance
Check the fit of the drive casing and make sure that the door leaves do not streak during opening.	After each removal of the casing
Check guide rollers of top center guide for wear and play.	With every maintenance Exchange after 5 years
Check folding joints for bearing play.	With every maintenance Replacement if too much bearing play
Check floor guide rollers and guide rail and remove dirt.	With every maintenance Replacing the floor guide rollers after 3 years
When opening, check the inner lever for proper disengagement when the door leaves are obstructed.	With every maintenance Replacement if too much play
Check whether the latch has too much play, so that the door leaves sway when opening and closing.	With every maintenance Replacement if too much play
Check the tension of the two drive belts.	With every maintenance
Control VRR clearance.	With every maintenance
Check whether the door leaves can be pushed open manually to the "CLOSED" position. If necessary, readjust the eccentric.	With every maintenance
Rest of the inspection the same as for sliding doors.	With every maintenance

7.6 Door care

The entire system, including the sensors and safety devices, can be cleaned with a moist cloth and standard commercial cleaners (non-scouring, do not use any solvents). First test the cleaners on a hidden (not easily visible) place. Keep all guides free of dirt.



NOTICE

It is recommended that for carrying out this work, the operating mode  (Locked) or  (Continuously open) be used, so as to avoid possible injuries from unwanted door movements.

7.7 Recommended and planned spare- and wear parts



NOTICE

Depending on the version of the door installed, not all the listed spare and wear parts are installed.

Spare part/Wear part	Interval
* <u>CO48</u> (Silicon or Rubber)	1 year
* Mechanical power storage device for escape routes in France	
* Pulley CO48	3 years
Battery	3 years
Antistatic brush	3 years
Door leaf guide (plastic)	3 years
Guiding pad	3 years
Safety blocking ball (<u>TOS</u> Break-out system)	5 years
Pulley	In case of wear
Gear belt	In case of wear
Roller, wheel	In case of wear
Counter wheel	In case of wear
Track	In case of wear
Carriage + Track + Rubber damping profile	In case of wear
Belt clamp	In case of wear
Hinge (plastic) for cladding height 200 mm	In case of wear
Locking device (<u>VRR</u>)	In case of wear
Motor	In case of wear
Leaf central seal	In case of wear
Lateral sealing profile	In case of wear
Floor guide rail	In case of wear
Light barrier	In case of wear
Control	In case of failure
Control unit	In case of failure
BBGV Green break glass housing	In case of failure
Others	In case of failure

7.8 Conclusion and reporting

- Fill out all documents, in particular, list defects in the Check list of the Inspection book.
- The customer / operator must be verbally informed of any defects.
- Obtain signature from the customer / operator and service technician (expert).
- Submit the documents to the customer / operator after the on-site acceptance inspection.
- Hand over the keys for the control units.

8 Emergency actuation of the door

8 Emergency actuation of the door

Since subject to country-specific safety instructions (Emergency exit concept), the doors are equipped with an emergency exit device.

8.1 Operating door in emergency

In accordance with country-specific safety regulations (concept of emergency exit, etc.) the doors are fitted with an emergency opening device.

8.2 Emergency opening with current supply

By activating the emergency opening switch (optional), which must be placed beside the installation, the door will open as long as the operating mode "Locked" has not been selected. In this operating mode the door will remain locked.

To re-start the installation, the emergency opening switch must be reset by hand, either through a rotation or a pulling (different procedures depending on the version of the switch).

8.3 Emergency opening in case of power failure with a back-up battery (optional)

- If a back-up battery is fitted and parametrized as "Battery operation", all functions of the automatic door will continue to be available.
- In case of a power failure, emergency opening is ensured by a back-up battery that opens the door once (except if the program is set to "Locked").
- The number of door openings depends mainly on door weight and the battery's charging state.
- The last door operation in case of a weak battery (insufficient capacity) is selectable: "Open" or "Close".
- If the door is in the "Locked" state, it can be unlocked by means of the key switch/push button (optional).

8.4 Emergency operating using Bowden cable (option)

This device, available in several versions, is mounted inside and/or outside and allows the unlocking of the door according to the procedure below.

8.4.1 Available versions

The available versions are illustrated below. They are basically identical in their function.

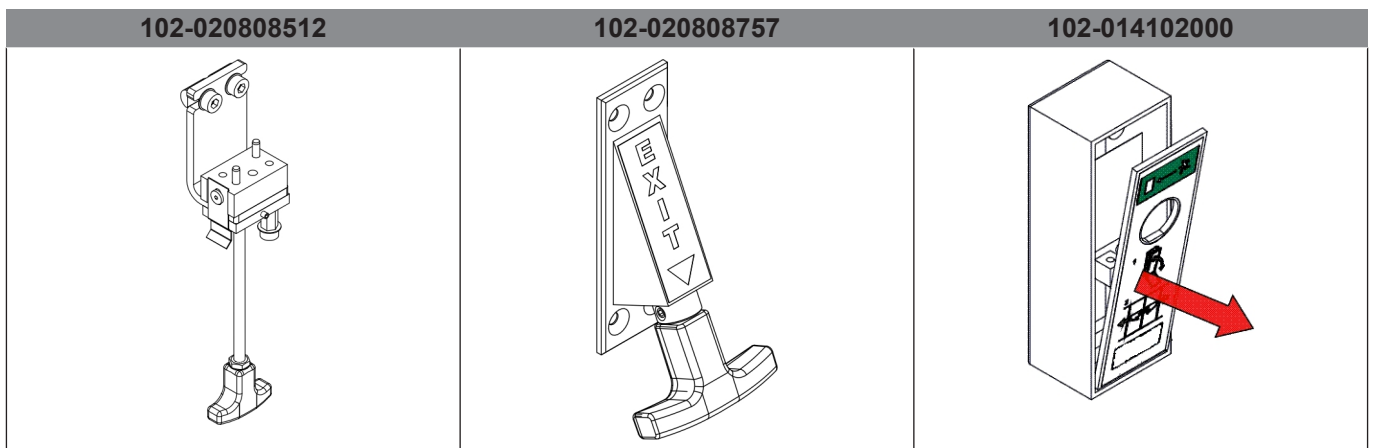

8.4.2 Procedure for an emergency opening

Emergency opening

- Open the unlocking flap.
- Pulling the unlocking flap downwards unlocks the door.
- Display on the BDE-D.
→ Error No. 31 / Emergency stop
- The door can be slid open by hand.

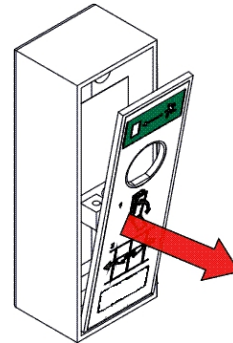

8.4.3 Procedure for an FBO emergency opening

Emergency opening FBO

- Opening the unlocking flap
- Pulling the unlocking flap downwards will unlock the door
- Display on the Operating unit
→ Error no. 31 / EMERGENCY STOP
- Door can be swung open manually

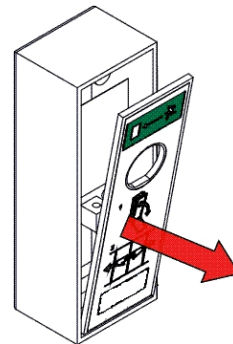

8 Emergency actuation of the door

8.5 Manual closing



Initial situation: Power supply is present. Door remains blocked in open position.



NOTICE

Depending on the type of fault, the procedure for closing the door manually varies. Follow the steps described below.

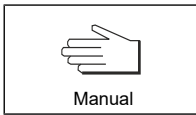
8.5.1 Manual closing - Step 1

Key	Function	Display	Description
	Manual mode	 Manual	<ul style="list-style-type: none"> – Press key 2 x in succession. – The door can be closed or opened manually. <p>Makeshift door operation (e.g. at low outside temperature)</p>
	Locked	 Locked	<ul style="list-style-type: none"> – Night locking – Press <i>additionally</i> the “Locked” key. – Push the door manually to the closed position. – Door is closed and locked (if locking device is present). <p>Notify service center. (Phone number is shown on the display)</p>



NOTICE

If the door still cannot be operated and locked manually, perform the steps described below.

8.6 Closing and locking the door

Procedure for closing and locking the door

- Activate the emergency opening.
- This causes the locking device to be unlocked.

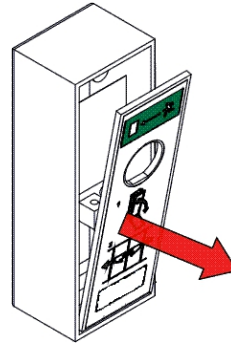

- Slide the door manually into the closed position.
- Keep the door leaves in the closed position.

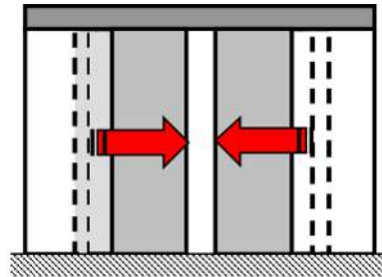

- Close the unlocking flap.
- The door is now locked.

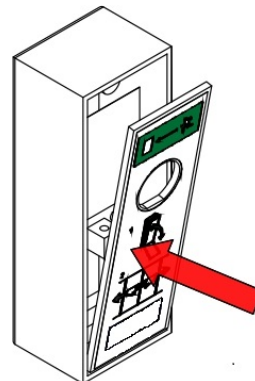

- Check manually if the door is really locked.

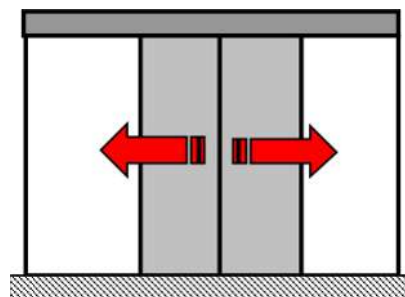
**NOTICE**

Same procedure for the other operating elements.

9 Troubleshooting

9 Troubleshooting

9.1 Error display and troubleshooting



NOTICE

Information regarding display texts, status and fault numbers can be found in the book B8A / 102-020401152.

9.2 Behavior in event of faults

In the event of an irregularity or malfunction, different displays are shown depending on the connected control unit.



NOTICE

If malfunctions that endanger the safety of individuals occur, the system must be turned off. It may not be turned back on until the problem has been resolved by a professional and the danger no longer exists.



NOTICE

If the system performs a slow opening or closing movement, this may be a deliberate, automatic redundancy test (self-test).



9.2.1 Display on the control unit

- Status messages are displayed with status number and text.
- The display changes alternately from white to black.
- After 10 seconds, the telephone number of the relevant service centre is alternately displayed.

9.2.2 BDE-D Possible troubleshooting

- Due to the status display, malfunctions can be partially remedied by the user himself.
- If you are not sure, contact the responsible service center.
- Before calling, note the information that can be seen on the display of the BDE-D Operating Unit. This information gives the technician important information for possible troubleshooting.
- If several status messages are active at the same time, they are numbered:
e.g. error 1 / 2.
- Pressing the E-key permits to navigate from one error message to the next one.

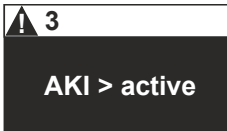

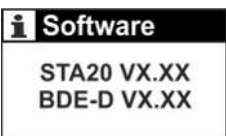
Example:

Which information?	Procedure	How displayed? (Example)
Status text and number	It is automatically displayed on the <u>BDE-D</u> .	 
Software-Versions	Press the following button on the <u>BDE-D</u> for 2 seconds. 	

9.2.3 Resetting the control unit

In some cases, the malfunction may be remedied by restarting the control unit. Please proceed as described below.

- Make sure that the drive cladding is closed and that nobody is obstructing the system or approaching it, thereby triggering an opening of the system.





Key	Selection	Display
		Press > 5 seconds
	No	No ----- Reset control?
	Yes	Yes

- Restart of the installation is performed.
- The first movement after a reset occurs at reduced speed.
- If a fault is still displayed on the control unit after resetting, please contact our service center **stating the error message**.

9.2.4 Control unit BDE-D does not react

If the control panel does not react when the keys are pressed or if no message appears on the display, a reset of the control panel could eliminate the problem.

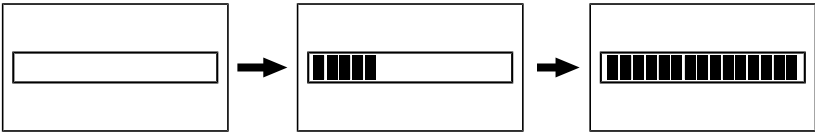
Proceed as follows:

RESET HARDWARE BDE-D	
	Press E key > 12 Sec.
	Display without any message.
	<p>Connecting to control unit.</p>  <p>Connection has been established (example).</p> 

- After resetting, the control panel is again operational.
- If this is not the case, please inform our service centre.

10 Taking out of service and disposal

10 Taking out of service and disposal

10.1 Decommissioning



NOTICE

After each temporary shutdown a new commissioning must be carried out.

When the system is taken out of service:

- a) Disconnect the system from the mains supply.
- b) Unplug from any existing battery.

10.2 Dismantling and disposal



NOTICE

All parts must be separated, sorted by the type of material, and disposed of. Refer to local regulations and guidelines.



NOTICE

The systems can be completely disassembled in the reverse order.

The installation mainly consists of the following materials:

Metal components (aluminium, steel, and iron)

- Linking profiles, system leaf profiles, side profiles, various profiles, and reinforcement profiles.
- Gearbox, drive panel.
- Gear components and springs.
- Stainless steel casing, floor panel, and box recess for the floor installation.
- Various small parts like fittings, covers, optional spacers, and linking parts.

Glass

- Leaves and side panels.

Various electronic and electromechanical components

- Sensors.
- Control components and operator components.
- Batteries and rechargeable batteries.

Various plastics

- Rollers.
- Sealing profiles.
- Cable clips, coupling and linking parts.
- Casing of electromechanical components and sensors.



Your global partner for entrance solutions